

Lecture 28

Different Types of Antennas—Heuristics

We have studied different closed form solutions and approximate solutions to Maxwell's equations. Examples of closed form solutions are transmission lines, waveguides, resonators, and dipoles solutions. Examples of approximate solutions are circuit theory and far field approximations. These solutions offer us physical insights into the behaviour of electromagnetic fields, and also the physical mechanisms as to how things work. With these physical insight, they inspire us for new designs.

Fortunately for us, Maxwell's equations are accurate from sub-atomic lengthscales to galactic lengthscales. In vacuum, they have been validated to extremely high accuracy. Furthermore, in the last few decades since the 1960s, very many numerical solutions have been possible for Maxwell's equations of complex structures. This field is known as computational electromagnetics, and many commercial software are available to solve Maxwell's equations to high fidelity. Therefore, design engineers these days need not have higher knowledge of math and physics, and the solutions of Maxwell's equations can be obtained by learning how to use commercial software. This is a boon to many design engineers: by running these software with cut-and-try engineering, wonderful systems can be designed. It used to be said that if we lock 100 monkeys in a room and let them punch at the 100 keyboards, they will never type out Macbeth nor Hamlet. But with 100 engineers locked up in a room with commercial software, with enough time and patience, they can come up with wonderful designs of different electromagnetic systems.

Modern antennas are designed by cut-and-try heuristics using physical insight and commercial software. In the parlance of the field, it is known as virtual proto-typing. With this, we can come up with different types of antennas for different applications [134]. We will discuss their functions heuristically in the following discussions.

28.1 Resonance Tunneling in Antenna

We realize the power of resonance enhancement when we were young and played on a swing in the park. By pumping the swing at its resonance frequency, we can cause it to swing at a large amplitude without a Herculean effort. A simple antenna like a short dipole behaves like a Hertzian dipole with an effective length. A short dipole has an input impedance resembling that of a capacitor. Hence, it is difficult to drive current into the antenna unless other elements are added. Hertz was clever by using two metallic spheres to increase the current flow. A large current flow on the stem of the antenna makes the stem resemble an inductor. Thus, the end-cap capacitances and the stem inductance together can act like a resonator enhancing the current flow on the antenna.

Some antennas are deliberately built to resonate with its structure to enhance its radiation. A half-wave dipole is such an antenna as shown in Figure 28.1 [127]. One can think that these antennas are using resonance tunneling to enhance their radiation efficiencies. A half-wave dipole can also be thought of as a flared open transmission line in order to make it radiate. It can be gradually morphed from a quarter-wavelength transmission line as shown in Figure 28.1. A transmission line is a poor radiator, because the electromagnetic energy is trapped between two pieces of metal. But a flared transmission line can radiate its field to free space. The dipole antenna, though a simple device, has been extensively studied by King [135]. He has reputed to have produced over 100 PhD students studying the dipole antenna.

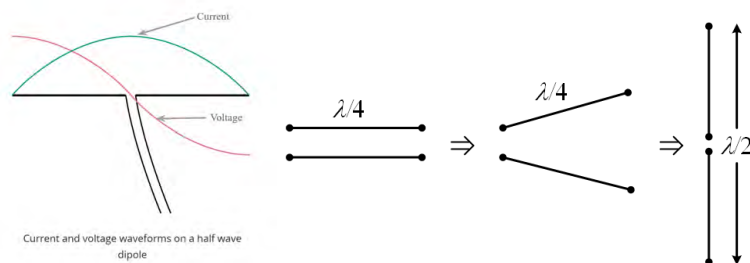

Figure 28.1: A half-wave dipole can be thought of as a resonator with radiation loss. It can be thought of as a quarter-wavelength transmission line that is gradually opened up (courtesy of electronics-notes.com).

The disadvantage of a half-wave dipole is that it has to be at least about half a wavelength before it radiates well. Engineers are creative, and they invent the folded dipole. For antennas of the same size, a folded dipole can resonate at a lower frequency because the current does not stop abruptly at its two ends. Figure 28.2 shows a Yagi-Uda antenna driven by a folded dipole.



Figure 28.2: A Yagi-Uda antenna was invented by heuristics in 1926. The principal element of the antenna is the folded dipole. When a wire dipole antenna is less than half a wavelength, it acts as a waveguide, or a director. When the wire antenna is slightly more than half a wavelength, it acts as a reflector [136]. Therefore, the antenna radiates predominantly in one direction (courtesy of Wikipedia [137]).

A Yagi-Uda antenna is also another interesting invention. It was invented in 1926 by Yagi and Uda in Japan by plainly using physical intuition [136]. Physical intuition was a tool of engineers of yesteryears while modern engineers tend to use sophisticated computer-aided design (CAD) software. The principal driver element of the antenna is the folded dipole. Surprisingly, the elements of dipoles in front of the driver element are acting like a waveguide in space, while the element at the back acts like a reflector. Therefore, the field radiated by the driver element will be directed toward the front of the antenna. Thus, this antenna has higher directivity than just a stand alone dipole. Due to its simplicity, this antenna has been made into nano-antennas which can radiate at optical frequencies [138].

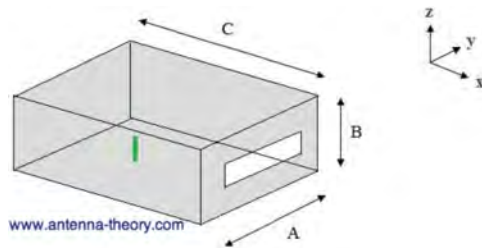

Figure 28.3: A cavity-backed slot antenna radiates well because when the small dipole radiates close to the resonant frequency of the cavity, the field strength is strongly enhanced inside the cavity, and hence around the slot. This makes the slot into a good radiator (courtesy of antenna-theory.com).

Slot antenna is a simple antenna to make [139]. To improve the radiation efficiency of slot

antenna, it is made to radiate via a cavity. A cavity-backed slot antenna that uses such a concept is shown in Figure 28.3. A small dipole with poor radiation efficiency is placed inside the cavity. When the operating frequency is close to the resonant frequency of the cavity, the field strength inside the cavity becomes strong, and much of the energy can leak from the cavity via the slot on its side. This makes the antenna radiate more efficiently into free space compared to just the small dipole alone.

Another antenna that resembles a cavity backed slot antenna is the microstrip patch antenna, or patch antenna. This is shown in in Figure 28.4. This antenna also radiates efficiently by resonant tunneling. The resonant frequency of the patch antenna (top of Figure 28.4) is roughly when L is half a wavelength. This is similar to the resonant frequency of a transmission line with open circuit at both ends. The current sloshes back and forth across the length of the patch antenna along the L direction. The second design (bottom of Figure 28.4) has an inset feed. This allows the antenna to resonate at a lower frequency because the current has a longer path to slosh through when it is at resonance.

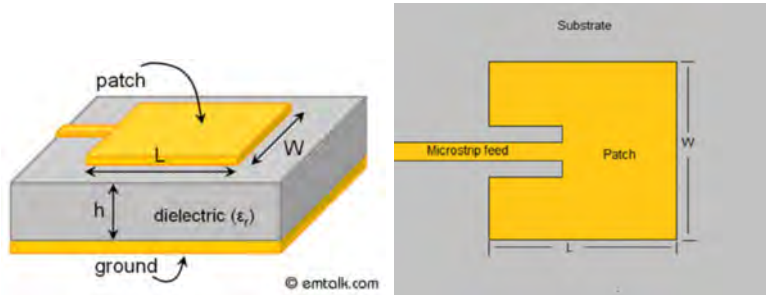

Figure 28.4: A microstrip patch antenna also radiates well when it resonates. The patch antenna resembles a cavity resonator with magnetic wall (courtesy of emtalk.com).

28.2 Horn Antennas

The impedance of space is 377 ohms while that of most transmission line is 50 ohms. This impedance mismatch can be mitigated by using a flared horn (see Figure 28.5) [140].

One can think that the characteristic impedance of a transmission line made of two pieces of metal as $Z_0 = \sqrt{L/C}$. As the horn flares, C becomes smaller, increasing its characteristic impedance to get close to that of free space. This allows for better impedance matching from the source to free space.

A corrugated horn, as we have discussed previously in a circular waveguide, discourages current flows in the non-axial symmetric mode. It encourages the propagation of the TE_{01} mode in the circular waveguide and hence, the circular horn antenna. This mode is axially symmetric. Thus, this antenna can radiate fields that are axially symmetric [141, 142].

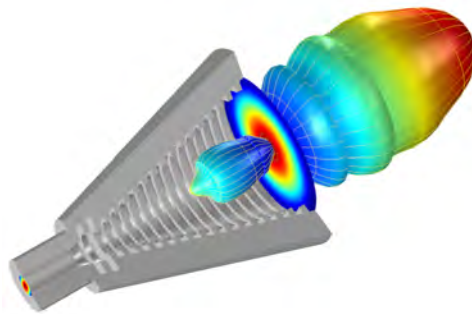
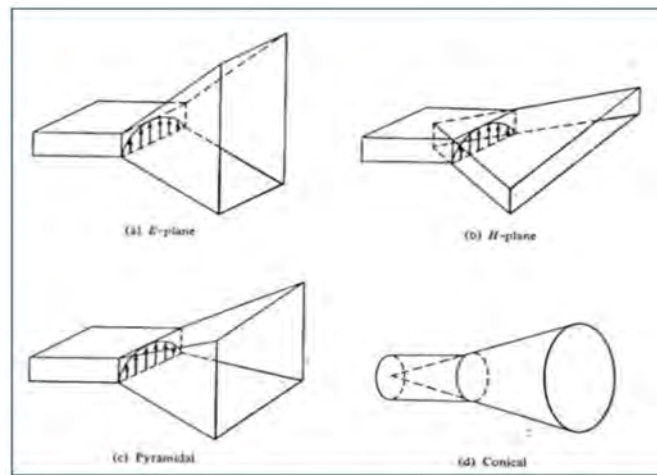

Figure 28.5: A horn antenna works with the same principle as the biconical antenna. Its flared horn changes the waveguide impedance so as to match from that of a waveguide to that of free space. The lower figure is that of a corrugated circular horn antenna. The corrugation enhances the propagation of the TE_{01} mode in the circular waveguide, and hence, the cylindrical symmetry of the mode and the radiation field (courtesy of tutorialpoints.com and comsol.com).

A Vivaldi antenna (invented by P. Gibson in 1978 [143]), is shown in Figure 28.6. It is also called a notch antenna. It works by the same principle to gradually match the impedance of the source to that of free space. But such a gradually flared horn has the element of a frequency independent antenna. The low frequency component of the signal will radiate from the wide end of the flared notch, while the high frequency component will radiate from the narrow end of the notch. Thus, this antenna can radiate well over a broad range of frequencies: this gives the antenna a broad bandwidth performance. It is good for transmitting a pulsed signal which has a broad frequency spectrum.

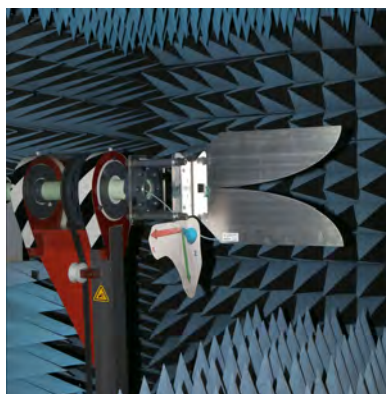

Figure 28.6: A Vivaldi antenna, also called a notch antenna, works like a horn antenna, but uses very little metal. Hence, it is cheap to build, and its flared notch makes it broadband (courtesy of Wikipedia [144]).

28.3 Quasi-Optical Antennas

High-frequency or short wavelength electromagnetic field behaves like light ray as in optics. Therefore, many high-frequency antennas are designed based on the principle of ray optics. A reflector antenna is such an antenna as shown in Figure 28.7. The reflector antenna in this case is a Cassegrain design [145]¹ where a sub-reflector is present. This allows the antenna to be fed from behind the parabolic dish where the electronics can be stored and isolated as well. Reflector antennas [147] are prevalent in radio astronomy and space exploration due to their high directivity and sensitivity.

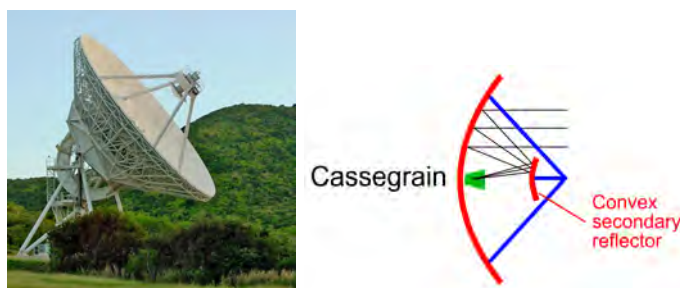

Figure 28.7: The left picture of an NRAO radio telescope antenna of Cassegrain design in Virginia, USA (courtesy of Britannica.com). The bottom is the detail of the Cassegrain design (courtesy of rev.com).

¹The name came from an optical telescope of similar design [146]

Another recent invention is the reflectarray antenna [148, 149] which is very popular. One of them is as shown in Figure 28.8. Due to recent advent in simulation technology, complicated structures can be simulated on a computer, including one with a complicated surface design. Patch elements can be etched onto a flat surface as shown, giving it effective impedance that is spatially varying, making it reflect like a curved surface. Such a surface is known as a meta-surface [150, 151]. It can greatly economize on the space usage compared to a reflector antenna.

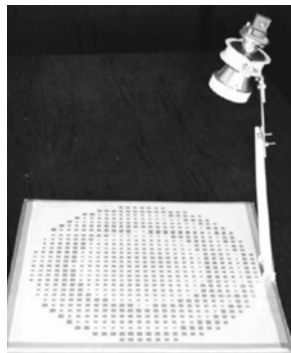

Figure 28.8: A reflectarray where the reflector is a flat surface. Patches are unequally spaced to give the array the focussing effect (courtesy of antenna-theory.com).

Another quasi-optical antenna is the lens antenna as shown in Figure 28.9 [152]. The design of this antenna follows lens optics, and is only valid when the wavelength is very short compared to the curvature of the surfaces. In this case, reflection and transmission at a curve surface is similar to that of a flat surface. This is called the tangent-plane approximation of a curve surface, and is valid at high frequencies.

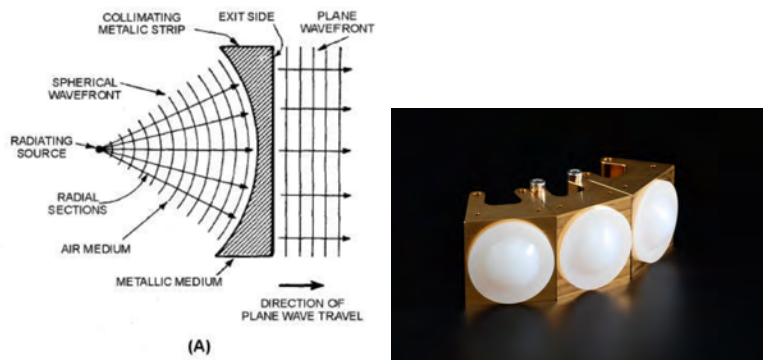

Figure 28.9: The left figure shows a lens antenna where the lens is made of artificial dielectrics made from metallic strips (courtesy of electriciantutoring.tpub.com). The right figure shows some dielectric lens at the aperture of an open waveguide to focus the microwave exiting from the waveguide opening (courtesy of micro-radar.de).

28.4 Small Antennas

Small antennas are in vogue these days due to the advent of the cell phone, and the importance of economizing on the antenna size due to miniaturization requirements. Also, the antennas should have enough bandwidth to accommodate the signals from different cell phone companies, which use different carrier frequencies. An interesting small antenna is the PIFA (planar inverted F antenna) shown in Figure 28.10 [153]. Because it is shorted at one end and open circuit at the other end, it acts like a quarter wavelength resonator, making it substantially smaller. But the resonator is low Q because of the “slots” around it from whom energy can leak. The low Q gives this antenna a broader bandwidth.

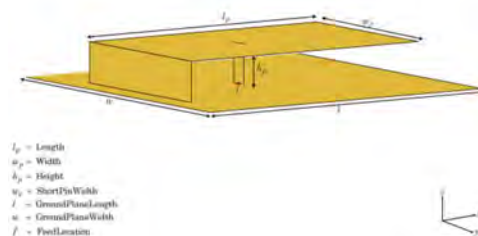

Figure 28.10: A PIFA (planar inverted F antenna) is compact, broadband, and easy to fabricate. It is good for cell phone antennas due to its small size (courtesy of Mathworks).

An interesting small antenna is the U-slot antenna shown in Figure 28.11 [154,155]. Because the current is forced to follow a longer torturous path by the U-slot, it has a lower resonant frequency and hence, can be made smaller. In order to give the antenna a larger bandwidth, its Q is made smaller by etching it on a thick dielectric substrate (shown as the dielectric material region in the figure). But feeding it with a longer probe will make the bandwidth of the antenna smaller, due to the larger inductance of the probe.² An ingenious invention is to use an L probe [156]. The L probe has an inductive part as well as a capacitive part. Their reactance cancel each other, allowing the electromagnetic energy to tunnel through the antenna, making it a better radiator.

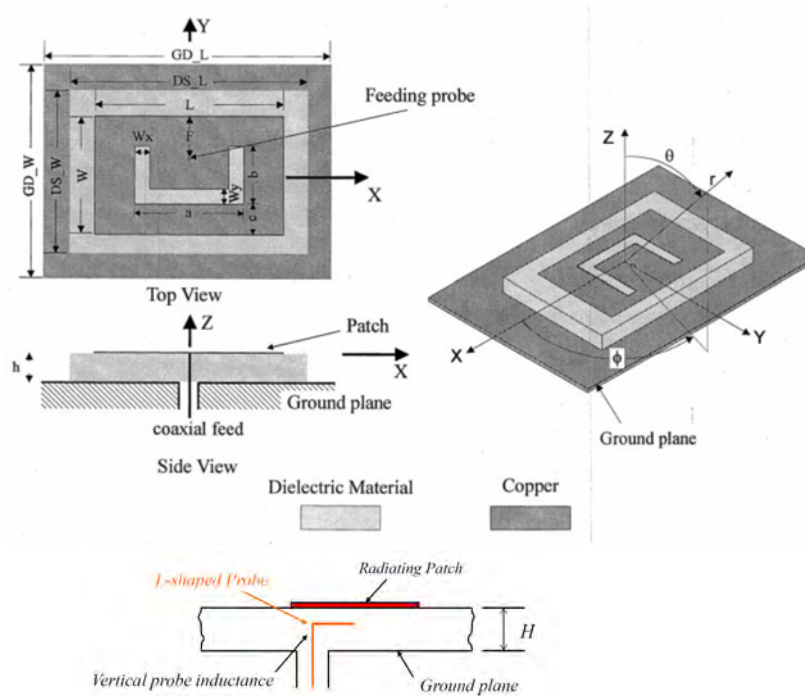

Figure 28.11: The top figure shows a U slot patch antenna design. The bottom figure shows a patch antenna fed by an L probe with significant increase in bandwidth (courtesy of K.M. Luk) [156].

Another area where small antennas are needed is in RFID (radio frequency identification) tag [157]. Since tags are placed outside the packages of products, an RFID tag has a transmit-receive antenna which can talk to a small computer chip where data about the package can be stored. An RFID reader can quickly and remotely communicate with the RFID tag to

²Remember that larger inductance implies more store magnetic field energy, and hence, the higher Q of the system.

retrieve information about the package. Such a small antenna design for RFID tag is shown in Figure 28.12. It uses image theorem so that the antenna can be made half as small. Then slots are cut into the radiating patch, so that the current follows a longer path. This lowers the resonant frequency of the antenna, allowing it to be made smaller.

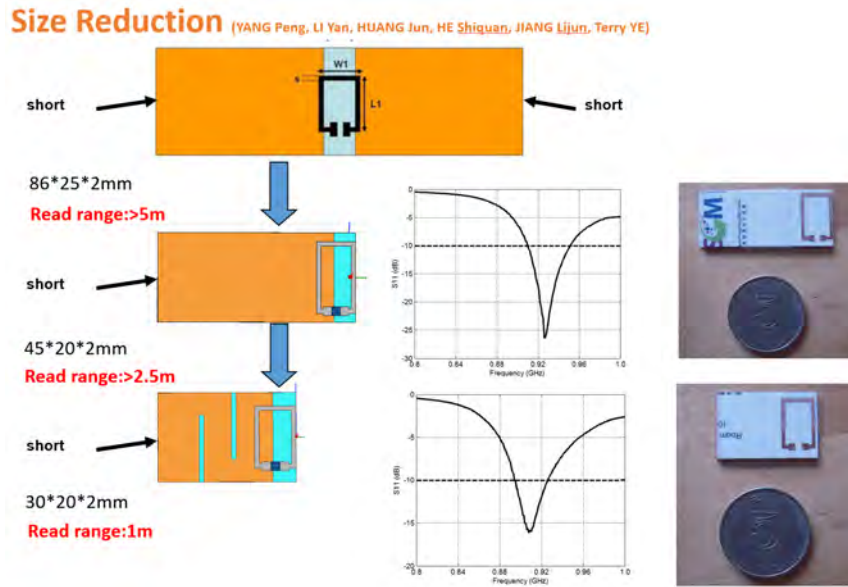

Figure 28.12: Some RFID antennas designed at The University of Hong Kong (courtesy of P. Yang, Y. Li, J. Huang, L.J. Jiang, S.Q. He, T. Ye, and W.C. Chew).

An RFID reader can be designed to read the information from a batch of vials or tubes containing different chemicals. Hence, a large loop antenna is needed at a sufficiently high frequency (for large bandwidth). However, driving a loop antenna at a sufficiently high frequency will result in a non-constant current around the loop. (Fundamentally, this comes from the retardation effect of electromagnetic field.) This will result in a non-uniform field inside the loop defeating the design of the RFID reader.

One way to view how the non-uniform current come about is that a piece of wire becomes a tiny inductor. Across an inductor, $V = j\omega LI$, implying a 90° phase shift between the voltage and the current. In other words, the voltage drop is always nonzero, and therefore, the voltage cannot be constant around the loop. Since the voltage and current are locally related by the local inductance, the current cannot be constant also.

To solve the problem of the current and voltage being non-constant around the loop, the local inductor is connected in series with a capacitor [158]. This causes them to resonate. At resonance, the current-voltage relationship across the tank circuit is such that there is no voltage drop across the tank circuit. In this case, the voltage becomes uniform across the loop so is the current. Therefore, one way to enable a uniform current in a large loop is

to capacitively load the loop. This will ensure a constant phase, or a more uniform current around the loop, and hence, a more efficient reader. Such a design is shown in Figure 28.13.

Square Segmented Loop

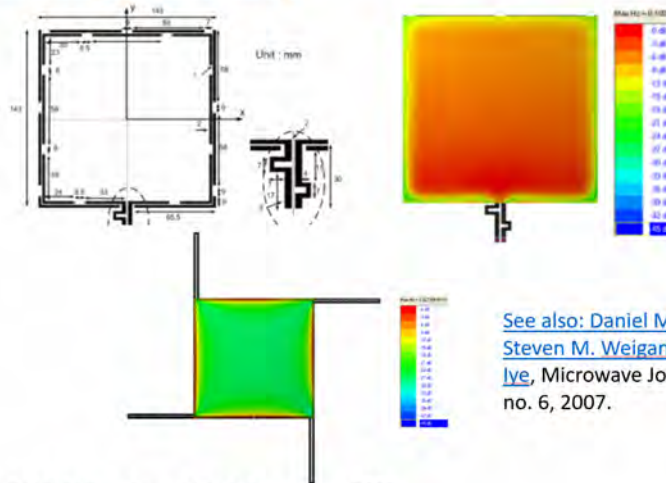

See also: Daniel M. Dobkin, Steven M. Weigand and Nathan Iye, *Microwave Journal*, vol.50, no. 6, 2007.

By CHEN Zhi Ning, from ASTAR, Singapore, 2009

Current Distribution and Measured S11

(YANG Peng, LI Yan, HUANG Jun, HE Shiguan, JIANG Lijun, Terry YE)

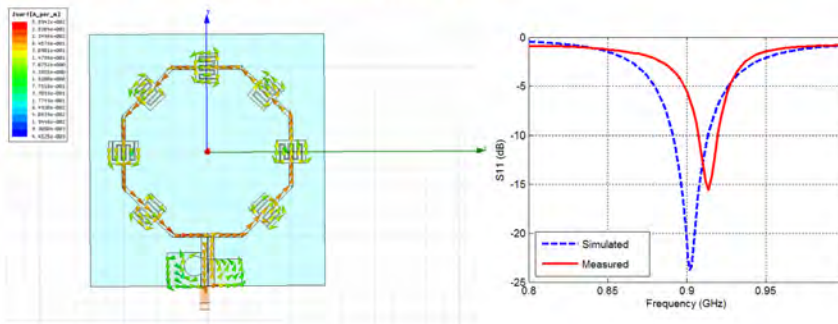

Figure 28.13: The top figure shows a RFID reader designed by [159]. The bottom figure shows simulation and measurement done at The University of Hong Kong (courtesy of Z.N. Chen [159] and P. Yang, Y. Li, J. Huang, L.J. Jiang, S.Q. He, T. Ye, and W.C. Chew).

